

Enclosure Type : PG 420 270 180		Size : 420 X 270 X 180		Weight : 2500 g.	
COVER	GEC00100 / A - Standard Grey	BASE	GEC00200 / A - Standard Grey		
	GEC00100 / B - High visibility yellow				

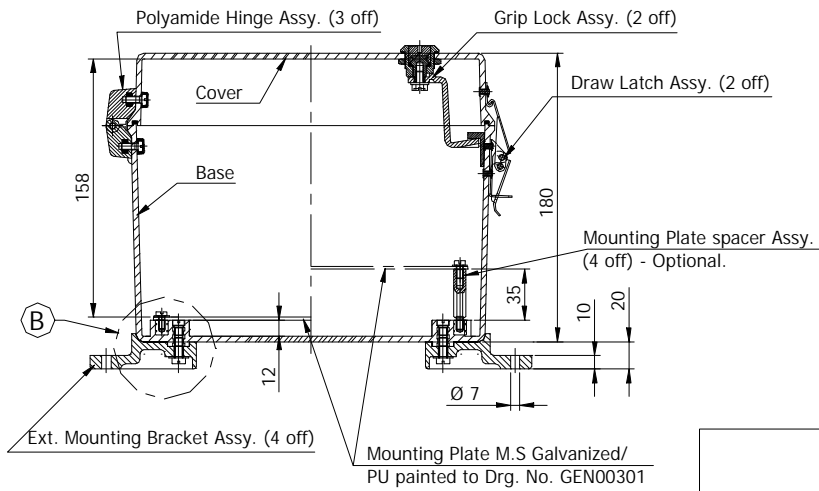

STD. ASSEMBLY PARTS	
DESCRIPTION	ORDER No.
S.S Cover Screw	EEN02900
Std. C/R Gasket	EEN05001
Alt. Silicon Gasket	EEN05101
Ext. Mounting Bracket Assy. Kit	GEA00100
Mounting Plate Assy. Kit	GEA00200

ACCESSORIES	
Mounting Plate Spacer Kit	GEA00300
Hinge Assy. Kit	GEA00401
Draw Latch Assy. Kit	GEA00500
Grip Lock Assy. Kit	GEA00600

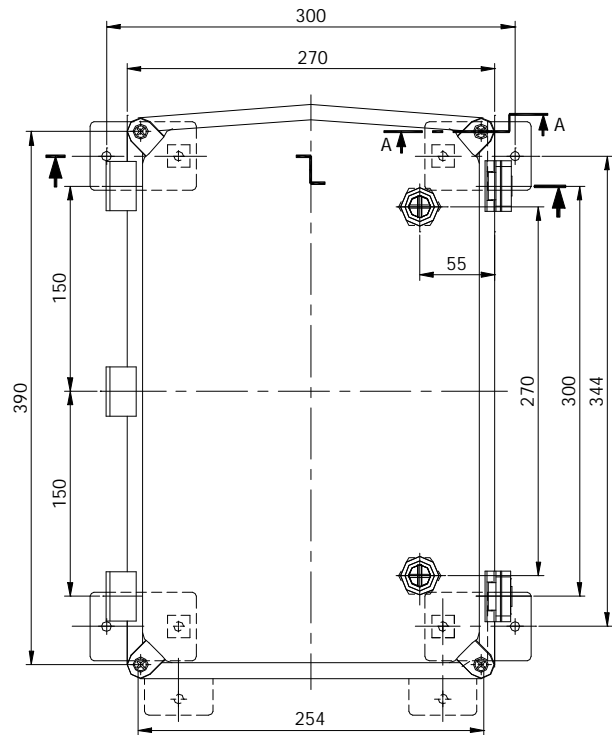

Maximum effective Inner area = 380 x 230 x 145

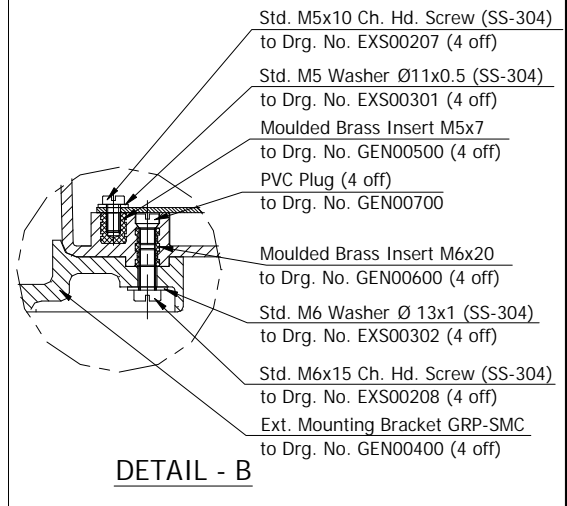
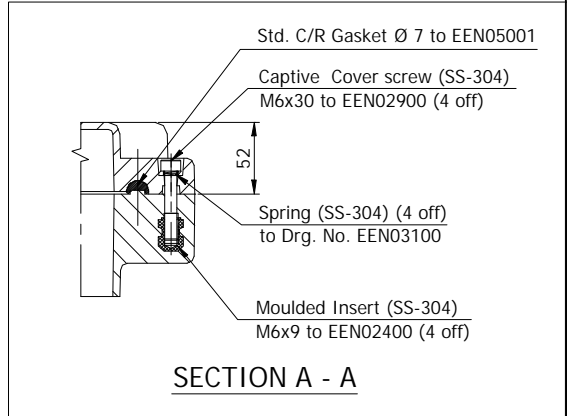

- 1) Weight 2500g is only Base & Cover without Mounting plate and External Mounting Bracket.
- 2) For 70 mm Mounting Plate Spacer Assy. use 2 Kits - GEA00300.